

9000 Rotary Switches 2A 250Vac



- ▶ Rotary action switch
- ▶ Ratings up to 2A, 250V ac
- ▶ 4 position, single pole
- ▶ 90° indexed positions



2A 250Vac T85

UL 2A 250Vac, 65°C, file E45221

RoHS compliant

μ contact gap.

Technical data on pages 4 & 5.

A 4-position single pole rotary switch. All nylon construction, threaded neck and flatted 6.0mm dia. spindle. Positive detent action, 90° between index positions. Stops available to restrict rotation.

Various circuits may be obtained by changing the supply and load connections or by omission of one or two terminals. Line and loads may be connected to any terminals. Any three of the four contacts are always connected. Illustrated loads and line are for example only.

Suitable for class II appliances. Patent app.

T9000

T 9000

TERMINAL CODE FUNCTION CODE

▶ ORDER FORMAT

▶ TERMINAL	▶ FUNCTION		▶ BODY	▶ OPTIONS
<p>T</p> <p>Solder</p>	<p>9000</p> <p>Position 1 Viewed from terminal side</p>	<p>Position 2</p>	<p>Panel Cut-out</p> <p>Panel thickness 1.25 - 3.5mm</p>	<p>Rotation Stops</p> <p>Can be specified to limit the number of switching positions</p>
	<p>Position 3</p>	<p>Position 4</p>		

Dimensions (mm)

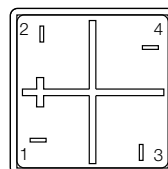
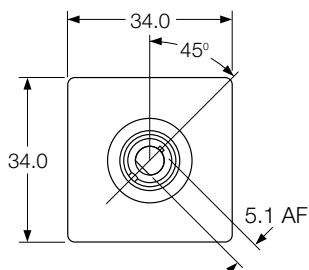
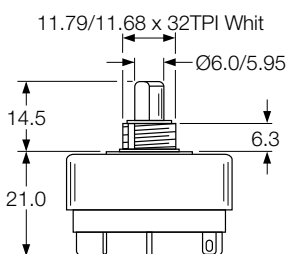

9100 Pull Cord Switches 16(4)A 250Vac



16(4)A 250Vac T125
16A 400Vac T125
8(8)A 250Vac T125 5E4 (50,000 Operations)



UL CSA 20A 277Vac, 250Vac 2hp, 125Vac 1hp
UL85°C, file no. E45221, CSA file no. LR10990



30A 12V dc

9100 pull cord switches have 45° indexing



RoHS compliant

3mm contact gap
Technical data on pages 4 & 5

- ▶ Pull cord operation
- ▶ Ratings up to 16A, 250V ac; 20A, 28V dc
- ▶ 2 & 4 way rotary switch
- ▶ Pairs of single pole change over contacts
- ▶ Wide choice of switching circuits

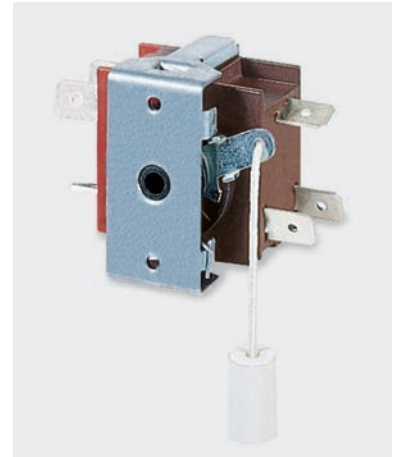

C9821PC ---

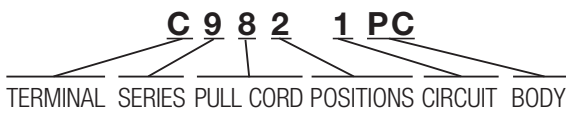

ORDER FORMAT

▶ TERMINAL	▶ SERIES	▶ POSITIONS/CIRCUIT	▶ BODY/MOUNTING																																																													
<p>C</p> <p>6.3 x 0.8</p> <p>9.2</p>	<p>98</p>	<p>21 Off</p> <p>1</p> <table border="1"> <tr><td>Pts</td><td>1</td><td>2</td><td>3</td><td>4</td><td>5</td><td>6</td><td>7</td><td>8</td></tr> <tr><td>A</td><td>●</td><td>●</td><td>●</td><td>●</td><td>●</td><td>●</td><td>●</td><td>●</td></tr> <tr><td>G</td><td>●</td><td>●</td><td>●</td><td>●</td><td>●</td><td>●</td><td>●</td><td>●</td></tr> <tr><td>1</td><td></td><td></td><td></td><td></td><td></td><td></td><td></td><td></td></tr> </table>	Pts	1	2	3	4	5	6	7	8	A	●	●	●	●	●	●	●	●	G	●	●	●	●	●	●	●	●	1									<p>PC</p> <p>2 hole fixing</p> <p>18.0</p> <p>9.0</p> <p>2 Holes Ø2.55</p> <p>28.0</p> <p>37.5</p>																									
Pts		1	2	3	4	5	6	7	8																																																							
A		●	●	●	●	●	●	●	●																																																							
G	●	●	●	●	●	●	●	●																																																								
1																																																																
<p>H</p> <p>4.8 x 0.8</p> <p>9.2</p> <p>For approval information on H terminals, contact sales</p>	<p>22 Off</p> <p>1+3</p> <table border="1"> <tr><td>Pts</td><td>1</td><td>2</td><td>3</td><td>4</td><td>5</td><td>6</td><td>7</td><td>8</td></tr> <tr><td>A</td><td>●</td><td></td><td>●</td><td>●</td><td>●</td><td>●</td><td>●</td><td>●</td></tr> <tr><td>G</td><td>●</td><td></td><td>●</td><td>●</td><td>●</td><td>●</td><td>●</td><td>●</td></tr> <tr><td>1</td><td></td><td></td><td></td><td></td><td></td><td></td><td></td><td></td></tr> <tr><td>3</td><td></td><td></td><td></td><td></td><td></td><td></td><td></td><td></td></tr> </table>	Pts	1	2	3	4	5	6	7	8	A	●		●	●	●	●	●	●	G	●		●	●	●	●	●	●	1									3																										
Pts	1	2	3	4	5	6	7	8																																																								
A	●		●	●	●	●	●	●																																																								
G	●		●	●	●	●	●	●																																																								
1																																																																
3																																																																
	<p>41 Off</p> <p>1+3</p> <p>2+4</p> <p>1+2+3+4</p> <table border="1"> <tr><td>Pts</td><td>1</td><td>2</td><td>3</td><td>4</td><td>5</td><td>6</td><td>7</td><td>8</td></tr> <tr><td>A</td><td>●</td><td>●</td><td>●</td><td>●</td><td>●</td><td>●</td><td>●</td><td>●</td></tr> <tr><td>G</td><td>●</td><td>●</td><td>●</td><td>●</td><td>●</td><td>●</td><td>●</td><td>●</td></tr> <tr><td>1</td><td></td><td></td><td></td><td></td><td></td><td></td><td></td><td></td></tr> <tr><td>2</td><td></td><td></td><td></td><td></td><td></td><td></td><td></td><td></td></tr> <tr><td>3</td><td></td><td></td><td></td><td></td><td></td><td></td><td></td><td></td></tr> <tr><td>4</td><td></td><td></td><td></td><td></td><td></td><td></td><td></td><td></td></tr> </table> <p>For other circuits please contact sales</p>	Pts	1	2	3	4	5	6	7	8	A	●	●	●	●	●	●	●	●	G	●	●	●	●	●	●	●	●	1									2									3									4								
Pts	1	2	3	4	5	6	7	8																																																								
A	●	●	●	●	●	●	●	●																																																								
G	●	●	●	●	●	●	●	●																																																								
1																																																																
2																																																																
3																																																																
4																																																																

Dimensions (mm)

9100PC (C terminals shown)

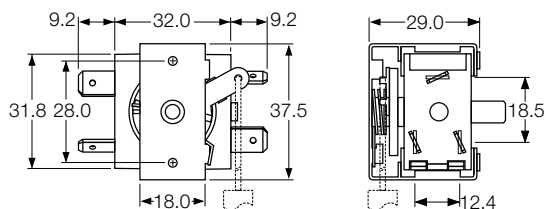

9100 Rotary Switches 16A 250Vac

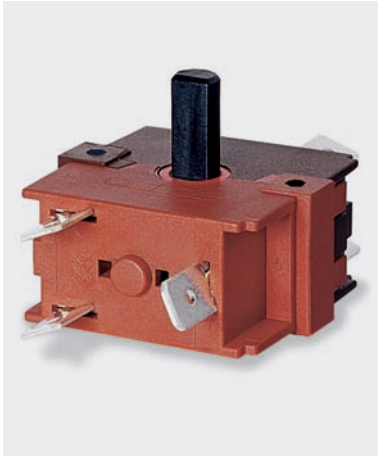

- ▶ 2 to 6 position rotary switch
- ▶ Ratings up to 20A, 277 Vac Non Inductive
- ▶ Pairs of single pole change over contacts
- ▶ Wide choice of switching circuits
- ▶ Can be stacked together



16(4)A 250Vac T125
16A 400Vac T125

8(8)A 250Vac T125 5E4 (50,000 Operations)



UL CSA 20A Non Ind 277Vac, 250Vac 2hp, 125Vac 1hp
UL 85°C, file no. E45221, CSA file no. LR10990

In house test

30A 12V dc



RoHS compliant

9100 switches are highly versatile with up to 6 positions at 30° intervals and 6 terminals per switch. For more complex switching (7 positions & over), contact sales. Two switches may be stacked to give up to 12 terminal switching.

3mm contact gap.

Technical data on pages 4 & 5.

C 9 5 01 D A Stop at 120°

TERMINAL CODE SERIES CODE POSITIONS CODE CIRCUIT CODE SHAFT CODE BODY CODE OPTIONS

ORDER FORMAT

▶ TERMINAL	▶ SERIES	▶ POSITION	▶ CIRCUIT	▶ SHAFT																											
<p>C</p> <p>6.3 x 0.8</p>	9	<p>2</p> <p>Switching positions</p>	<p>9100 switches offer almost infinite switching options</p> <p>For this reason it is impractical to show all the options available.</p> <p>The table below gives an example of a 5 position switching sequence: OFF, 1, 1+2, 1+2+3, 1+2+3+4</p> <table border="1"> <tr> <td>Off</td> <td>Pos 1</td> <td>Pos 2</td> <td>Pos 3</td> <td>Pos 4</td> <td>Pos 5</td> </tr> <tr> <td></td> <td></td> <td></td> <td></td> <td></td> <td></td> </tr> <tr> <td>A</td> <td></td> <td></td> <td></td> <td></td> <td></td> </tr> <tr> <td>B</td> <td></td> <td></td> <td></td> <td></td> <td></td> </tr> </table>	Off	Pos 1	Pos 2	Pos 3	Pos 4	Pos 5							A						B						<p>A</p> <p>B</p> <p>C</p> <p>N</p> <p>A - Dim. X = 26.0 B - Dim. X = 22.0 C - Dim. X = 10.8 N - Dim. X = 20.0 K - Dim. X = 13.0</p> <p>D</p> <p>D - Dim. X = 12.2 T - Dim. X = 18.0</p> <p>M</p> <p>P</p> <p>R</p> <p>S</p> <p>L supplied without shaft</p>			
Off		Pos 1		Pos 2	Pos 3	Pos 4	Pos 5																								
A																															
B																															
<p>H</p> <p>4.8 x 0.8</p> <p>For approval information on H terminals, contact sales.</p> <p>Simple circuits may not use all terminals. Unnecessary terminals may be omitted.</p>		<p>3</p> <p>Switching positions</p>		<p>4</p> <p>Switching positions</p>	<p>5</p> <p>Switching positions</p>																										
	<p>5</p> <p>Switching positions</p>	<p>6</p> <p>Switching positions</p>	<table border="1"> <tr> <td></td> <td>Pos 1</td> <td>Pos 2</td> <td>Pos 3</td> <td>Pos 4</td> <td>Pos 5</td> <td>Pos 6</td> </tr> <tr> <td></td> <td></td> <td></td> <td></td> <td></td> <td></td> <td></td> </tr> <tr> <td>A</td> <td></td> <td></td> <td></td> <td></td> <td></td> <td></td> </tr> <tr> <td>B</td> <td></td> <td></td> <td></td> <td></td> <td></td> <td></td> </tr> </table>		Pos 1	Pos 2	Pos 3	Pos 4	Pos 5	Pos 6								A							B						
	Pos 1	Pos 2	Pos 3	Pos 4	Pos 5	Pos 6																									
A																															
B																															

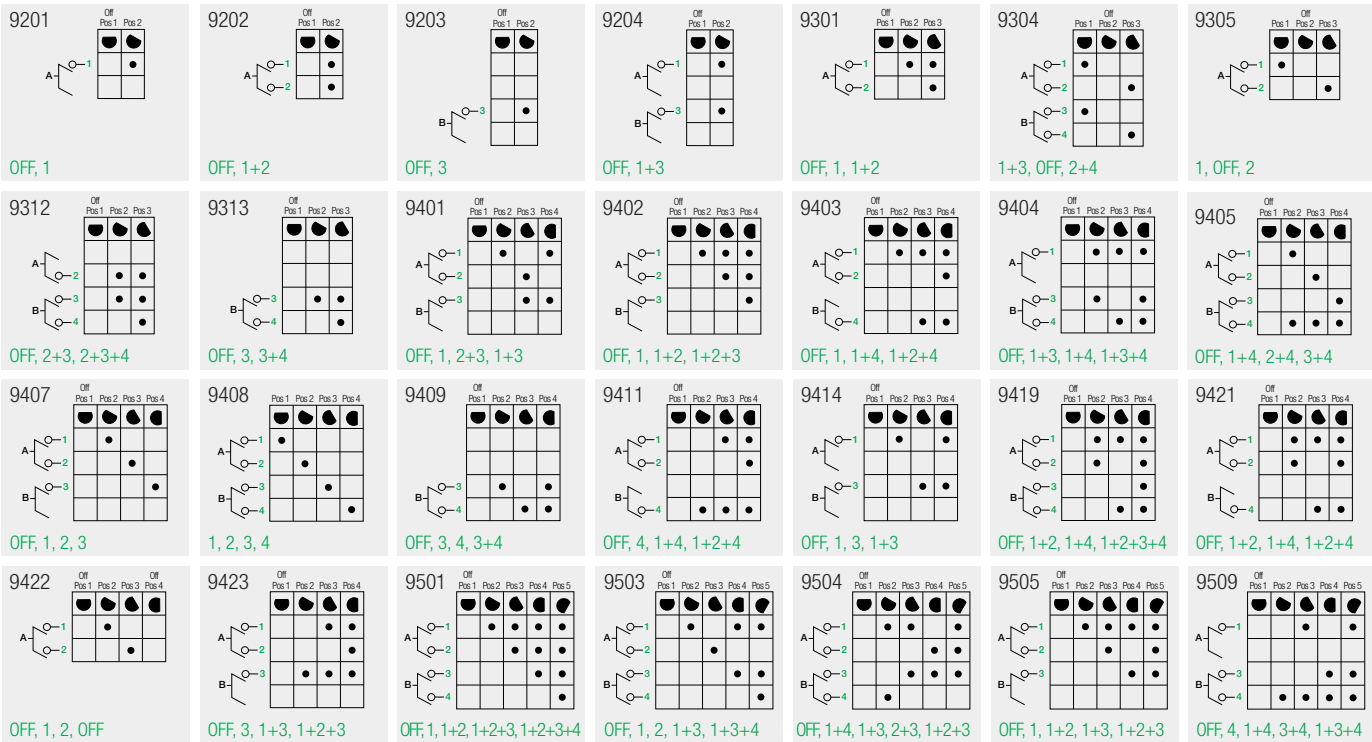

BODY

A
Standard 2 hole mounting

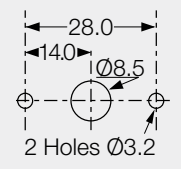

Recommended Mounting
2 each of No4 / 3.0mm self tapping screws
5.0mm min penetration into switch body.

Stacked Switches
For more complex switching a second switch may be stacked on the first.

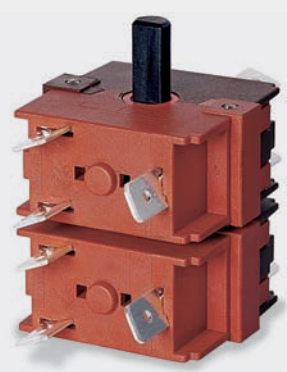

OPTIONS

Anti-rotation stops
May be fitted at any of the index positions to limit the maximum angle of rotation.

Panel clearance
A spacer can be fitted to the switch body to increase the clearance between the mounting panel and switch terminals.

Custom shafts
Custom shafts of any length, with or without a "D" flat, can be produced from our infinitely variable tooling. The flat can be at any angle.

For all options call sales.

DIMENSIONS (mm)

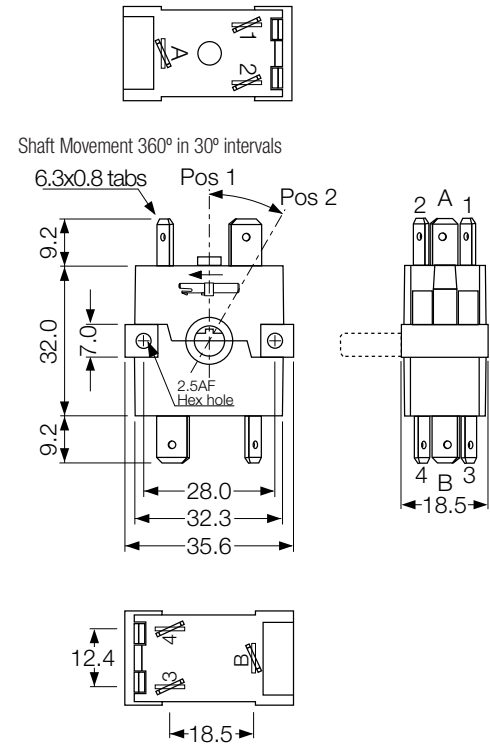

Note
In the circuits on this page, the symbol ● shows the position of the switch cam, NOT the position of the shaft flat.

rotary switches