

2000 Slide Switches - up to 5 position 10A 250Vac

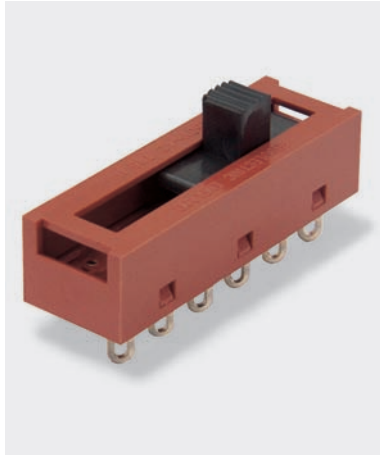

- ▶ Slide switches
- ▶ Ratings up to 16A, 250V ac
- ▶ PCB and solder terminals
- ▶ 2, 3, 4 and 5 position
- ▶ Choice of circuits
- ▶ Choice of actuators



10A 250Vac T85
6(3)A 250Vac T85



UL CSA 16A 250Vac Non Inductive
UL CSA 4A 300Vac
UL 65°C, file no. E45221, CSA file no. LR10990



RoHS compliant

μ contact gap

Please specify: Standard action (SP116) or Light action (SP118).
2000 series lubrication is inorganic and does not degrade plastics.

Technical data on pages 4 & 5.

T 2 2 20 5 A

TERMINAL CODE SERIES CODE POSITIONS CODE CIRCUIT CODE SLIDER CODE BODY CODE

ORDER FORMAT

TERMINAL	SERIES	POS'N	CIRCUIT <small>Viewed from back</small>	SLIDER	
K 2.8 x 0.8	2	2 Switching positions	10	0	
R 2.8 x 0.8			20	6	
			T Solder	30	D
				X PCB 0.8 Sq.	40
		Y PCB 0.8 Sq. For mounting stability switches have extra "support" terminals * Nominal - Dimension varies with body type. For exact figure call sales			10
3 Switching positions					20
			4 Switching positions		30
				5 Switching positions	40
		10			2
20					3
			30		A
				40	H
		11 9 7 5 3 1 12 10 8 6 4 2			4
11 9 7 5 3 1 12 10 8 6 4 2					5
			11 9 7 5 3 1 12 10 8 6 4 2		C
				11 9 7 5 3 1 12 10 8 6 4 2	

slide switches



X22205C ---



T2220EC ---

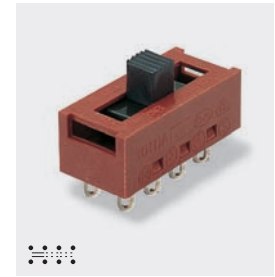

T23206A ---



T24306A ---



T25302A ---

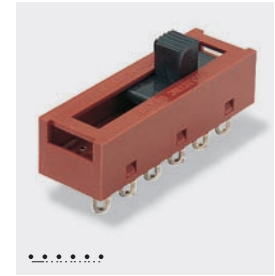

T25100A ---

BODY

C 2 positions

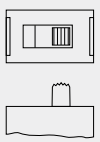

H 2 positions

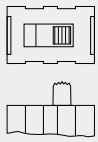

A 3 positions

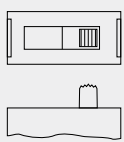

H 3 positions

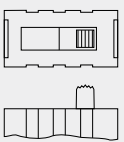

A 4 positions

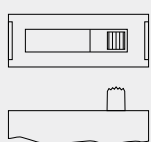

H 4 positions

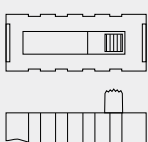

A 5 positions

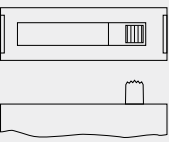

OPTIONS

Color

For custom slider colors call the factory. A full range is available for large orders

DIMENSIONS (mm)

2 Position C body

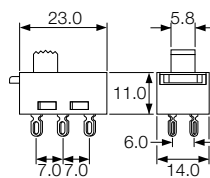

2 Position H body

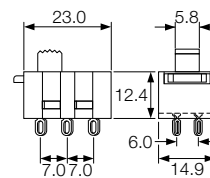

Cut-out/PCB Matrix

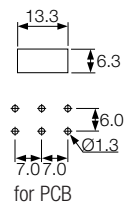

3 Position A body

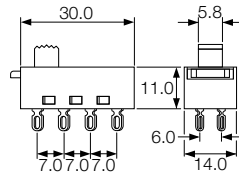

3 Position H body

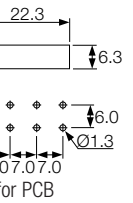
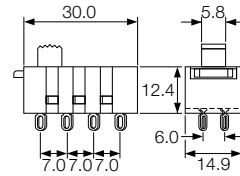

4 Position A body

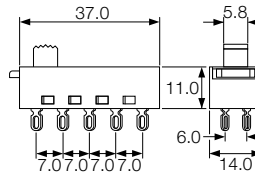

4 Position H body

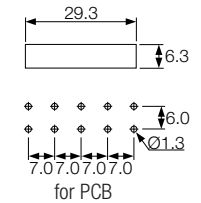
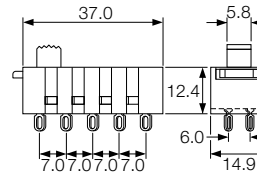

5 Position A body

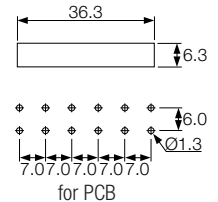
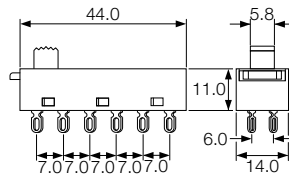

2000 Slide Switches - Snap fit and panel mount 10A 250Vac

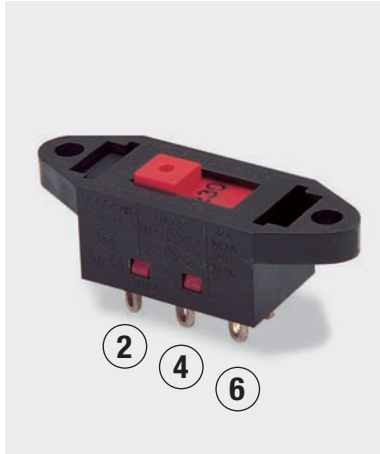

- ▶ 2 way 'voltage selector'
- ▶ Ratings up to 16A, 250V ac
- ▶ Snap fit and panel mount
- ▶ PCB & solder terminals
- ▶ 2 and 3 position
- ▶ Choice of circuits
- ▶ Choice of actuators



10 A 250Vac T85
6(3)A 250Vac T85



UL CSA 16A 250Vac Non Inductive
UL CSA 4A 300Vac
UL 65°C, file no. E45221, CSA file no. LR10990



RoHS compliant

μ contact gap

Please specify: Standard action (SP116) or light action (SP118).
2000 series lubrication is inorganic and does not degrade plastics.

Technical data on pages 4 & 5.

115/230 is preferred legend

B BLACK
W WHITE
R RED

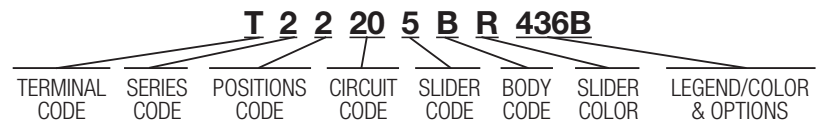

ORDER FORMAT

TERMINAL	SERIES	POS'N	CIRCUIT <small>Viewed from back</small>	SLIDER									
K 2.8 x 0.8		2 Switching positions	10 	0 2 Pos B Body only 	6 2 & 3 Pos B Body only 	C 2 & 3 Pos B Body only 	L 2 & 3 Pos B Body only Limited travel on 2 pos 	S Limited travel on 2 pos 2 & 3 Pos B Body only 					
			20 	2 2 Pos B Body only 	7 2 & 3 Pos B Body only 	D 2 & 3 Pos B Body only 	M F Body only Legend optional 	T 2 & 3 Pos B Body only 					
			30 	3 2 & 3 Pos B Body only 	8 E Body only Legend optional 	E 2 Pos B Body only Limited travel on 2 pos 	N 2 Pos B Body only 						
			40 	4 2 & 3 Pos B Body only 	9 2 & 3 Pos B Body only 	H 2 Pos B Body only 	P 2 & 3 Pos B Body only Limited travel on 2 pos 						
R 2.8 x 0.8		2	10 	5 2 Pos B Body only Also with legend 	A 2 Pos B Body only 	K 2 & 3 Pos B Body only Limited travel on 2 pos 	R 2 & 3 Pos B Body only 						
			20 	4 2 & 3 Pos B Body only 	9 2 & 3 Pos B Body only 	H 2 Pos B Body only 	P 2 & 3 Pos B Body only Limited travel on 2 pos 						
			30 	5 2 Pos B Body only Also with legend 	A 2 Pos B Body only 	K 2 & 3 Pos B Body only Limited travel on 2 pos 	R 2 & 3 Pos B Body only 						
			40 	5 2 Pos B Body only Also with legend 	A 2 Pos B Body only 	K 2 & 3 Pos B Body only Limited travel on 2 pos 	R 2 & 3 Pos B Body only 						
T Solder	2	2 Switching positions	10 										
			20 										
			30 										
			40 										
X PCB 0.8 Sq. For mounting stability switches have extra "support" terminals * Nominal - Dimension varies with body type. For exact figure call sales		3 Switching positions	10 										
			20 										
			30 										
			40 										

slide switches



T22208E ---



T22308E ---



T2230MF ---



T22205B ---



T22305B ---



T23204B ---

BODY

B With mounting holes

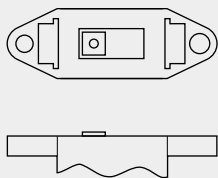

E Snap fit

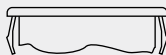

Cut-outs must be punched in the direction of insertion

F Snap fit (single pole ON OFF only)

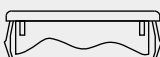
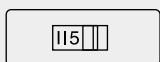

Cut-outs must be punched in the direction of insertion

OPTIONS

Color

For custom slider colors call the factory. A full range is available for large orders

Standard body color is black

Legend printing

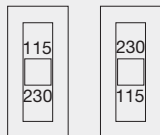

436() 437()

() is legend color
 (B) - Black
 (W) - White
 (R) - Red

Please call the sales for custom legends

DIMENSIONS (mm)

Cut-out / PCB Matrix

2 Pos B

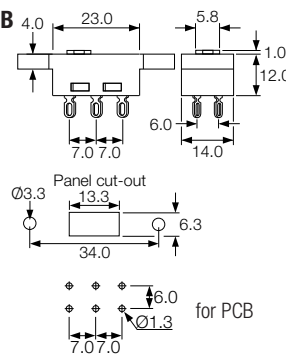

3 Pos B

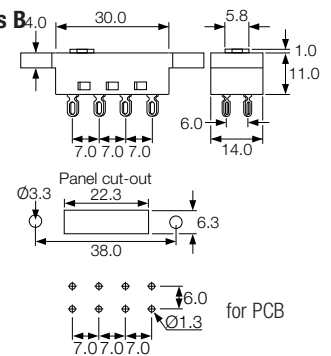

2 Pos E

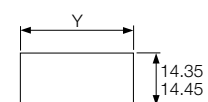
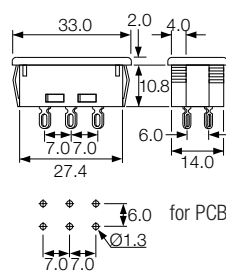

Panel thickness	Dim. Y
0.8-1.2	29.75/29.85
1.63	30.15/30.25
2.0	30.35/30.45
2.5	30.55/30.65

2 Pos F

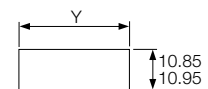
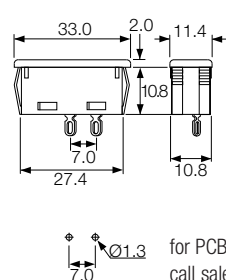

Panel thickness	Dim. Y
0.8-1.2	29.75/29.85
1.63	30.15/30.25
2.0	30.35/30.45
2.5	30.55/30.65

for PCB, call sales for details